

Han-Eco Mod.24-HSM1-M40

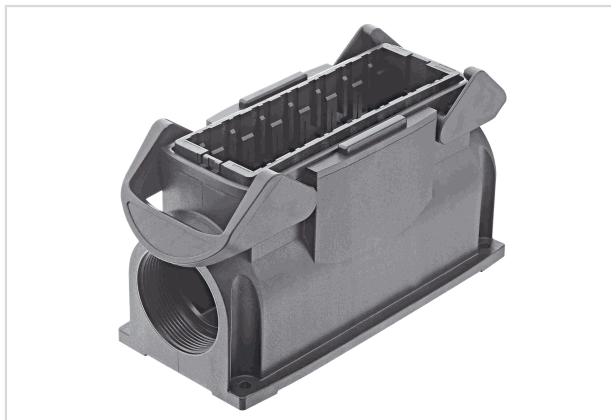

Image is for illustration purposes only. Please refer to product description.

Part number	19 41 024 0233
Specification	Han-Eco Mod.24-HSM1-M40
HARTING eCatalogue	https://b2b.harting.com/19410240233

Identification

Category	Hoods/Housings
Series of hoods/housings	Han-Eco® Modular
Type of hood/housing	Surface mounted housing

Version

Size	24 B
Module slots	7
Version	Side entry
Cable entry	1x M40
Locking type	Double locking lever

Technical characteristics

Limiting temperature	-40 ... +125 °C
Note on the limiting temperature	For use as a connector according to IEC 61984.
Number of relockings	≥500
Degree of protection acc. to IEC 60529	IP65

Material properties

Material (hood/housing)	Polyamide (PA) Fibre-glass reinforced
Colour (hood/housing)	RAL 9005 (jet black)
Material (seal)	NBR
Colour (seal)	RAL 9005 (jet black)



Pushing Performance
Since 1945

Material properties

Material (locking)	Polyamide (PA) Fibre-glass reinforced
Colour (locking)	RAL 9005 (jet black)
Material flammability class acc. to UL 94	V-0
Material flammability class acc. to UL 94 (locking levers)	V-0
RoHS	compliant
ELV status	compliant
China RoHS	e
REACH Annex XVII substances	Not contained
REACH ANNEX XIV substances	Not contained
REACH SVHC substances	Not contained
California Proposition 65 substances	Yes
California Proposition 65 substances	Naphthalene
Fire protection on railway vehicles	EN 45545-2 (2020-08)
Requirement set with Hazard Levels	R22 (HL 1-3) R23 (HL 1-3)

Specifications and approvals

Specifications	IEC 61984 EN 45545-2 Fire protection on railway vehicles
UL / CSA	UL 1977 ECBT2.E235076 CSA-C22.2 No. 182.3 ECBT8.E235076
CE	Yes

Commercial data

Packaging size	1
Net weight	281 g
Country of origin	Germany
European customs tariff number	85389099
GTIN	5713140131125
eCl@ss	27440202 Shell for industrial connectors